

PRODUCT MODBUS PROTOCOL

1. Data frames format:

RTU Mode : Communication Parameter: Baud rate 9600 bps.

Data frames: 1 Start bit, 8 data bits, even parity check, 1 stop bit.

2. Read angle data: (Modbus FUNC 03H.)

Host Computer Inquiry Command		Slave Computer Response	
Inclinometer Add	01H	Inclinometer Add	01H
FUNC	03H	FUNC	03H
Visit Register first Address	00H	Data Length	08H
	02H	Data word 1, high bits	50H
Data Length 4 bytes	00H	Data word 1, lower bits	46H
	04H	Data word 2, high bits	00H
CRC	E5C9H	Data word 2, lower bits	00H
		Data word 3, high bits	23H
		Data word 3, lower bits	20H
		Data word 4, high bits	00H
		Data word 4, lower bits	00H
		CRC	BD61H

Read the measured data command application example

Host computer sending 01H 03H 00H 02H 00H 04H E5H C9H

Slave computer response

01H 03H 08H 50H 46H 00H 00H 23H 20H 00H 00H BDH 61H

Note: Slave computer response data domain of the frames

is 50H, 46H, 00H, 00H, 23H, 20H, 00H, 00H

The X axis is the 1-4th byte of the data field, the Y axis is the 5th-8th byte of the data field, and the low byte is first. The representation of the angle is the point number representation. One point corresponds to 0.01°, and 0.01 × (point-offset) is the angle. If the measurement range is ±90°, the total number of points is 18000 points, so 0 corresponds to -90°, 18000 corresponds to +90°, 9000 corresponds to 0°.

Take the above data frame as an example: the angle conversion process is as follows:

- 1) Get the current angle points, the low byte is first, the X axis is 4650H, and the Y axis is 2023H.
- 2) Convert to decimal, X axis: 4650H → 18000, Y axis: 2023H → 8227.
- 3) Subtract the offset 9000 (note: this value is an amount related to the measurement range), X-axis: 18000-9000 = 9000, Y-axis: 8227-9000 = -773.
- 4) Get the final angle, X-axis: 9000 × 0.01 = 90.00°, Y-axis: -773 × 0.01 = -7.73°.

Read the measured data command application example

Host computer sending 01H 03H 00H 02H 00H 04H E5H C9H

Slave computer response

01H 03H 08H 00H 00H 00H 00H 23H 00H 00H 64H 1DH

Assuming that the sensor of this example has a measurement range of ±45 degrees, the total number of points is 9000 points. Therefore, 0 corresponds to 45°, 9000 corresponds to +45°, and 4500 corresponds to 0°. The angle conversion process is as follows:

- 1) Get the current angle points, the low byte is first, the X axis is 0000H, and the Y axis is 2300H.
- 2) Convert to decimal, X axis: 0000H → 0, Y axis: 2300H → 8960.
- 3) Subtract the offset 4500 (note: this value is an amount related to the measurement range), X-axis: 0-4500 = -4500, Y-axis: 8960-4500 = 4460.
- 4) Get the final angle, X-axis: -4500 × 0.01 = -45.00°, Y-axis: 4460 × 0.01 = 44.60°.

3. Setting inclinometer relative/absolute ZERO: Modbus FUNC 06H

Setting relative/absolute ZERO command		Slave Computer Response	
Inclinometer Add	01H	Inclinometer Add	01H
FUNC	06H	FUNC	06H
Access register address	00H	Register address	00H
	10H		10H
	00H		00H
Word nonzero is relative ZERO, word ZERO is absolute ZERO	FFH/00H	Word nonzero is relative ZERO, word ZERO is absolute ZERO	FFH/00H
	Relative/Absolute		Relative/Absolute
CRC	C84FH/880FH	CRC	C84FH/880FH

Read the measured data command application example

Host computer sending 01H 06H 00H 10H 00H FFH C8H 4FH

Slave computer response

01H 06H 00H 10H 00H FFH C8H 4FH

Note: 0010 is register address, the register control inclinometer output is relative ZERO or absolute ZERO. If nonzero (As example as above, was written in 00FFH), the output is relative ZERO. On contrary if zero (will change the fifth and sixth bytes to 00H), then is absolute ZERO, the last two bytes is CRC checksum.

4. Setting inclinometer address:

Setting inclinometer add code command		Slave computer response	
Inclinometer Add	01H	Inclinometer Add	01H
FUNC	06H	FUNC	06H
Access register first address	00H	Register address	00H
	11H		11H
Inclinometer New Add	00H	Inclinometer New Add	00H
	04H		04H
CRC	D80C	CRC	D80C

Read the measured data command application example

Host computer sending 01H 06H 00H 11H 00H 04H D8H 0CH

Slave computer response

01H 06H 00H 11H 00H 04H D8H 0CH

Note: 0011H is register address, the register control inclinometer address. Above example, the inclinometer address is changed to 0004H, the last two bytes is CRC checksum.

5. Set the sensor communication character format:

Set sensor communication character		Slave Computer Response	
Inclinometer Add	01H	Inclinometer Add	01H
FUNC	06H	FUNC	06H
Access register address	00H	Register address	00H
	09H		09H
Sensor change communication character format	00H	Sensor change communication character format	00H
	01/00H		01/00H
CRC	9800/59C8	CRC	9800/59C8

Set sensor communication character format

Host computer sending 01H 06H 00H 09H 00H 01H 98H 08H

Slave computer response

01H 06H 00H 09H 00H 01H 98H 08H

The above example sets the byte format to: 1 start bit + 8 data bits, no parity, + 1 stop bit; it will be valid after power-on. The factory default is 1 start bit + 8 data bits, even parity check + 1 stop bit;

Note: 0009 is the register address, this register controls the character format of sensor communication,

000H: One start bit + 8 data bits, even parity + 1 stop bit,

001H: one start bit + 8 data bits without parity + 1 stop bit.

6. Set sensor baud rate:

Set sensor baud rate character command		Slave Computer Response	
Inclinometer Add	01H	Inclinometer Add	01H
FUNC	06H	FUNC	06H
Access register address	00H	Register address	00H
	08H		08H
The sensor needs to change the baud rate parameter	00H	The new baud rate of the sensor	00H
	A2H		A2H
CRC	89B1	CRC	89B1

Set sensor baud rate character format

Host computer sending 01H 06H 00H 08H 00H A2H 89H B1H

Slave computer response

01H 06H 00H 08H 00H A2H 89H B1H

A1H: 4800 A2H: 9600 A3H: 19200 A4H: 38400 A5H: 115200



CE CERTIFICATION: ATSHAHE181129003
APPEARANCE PATENT : ZL 201830752891.5

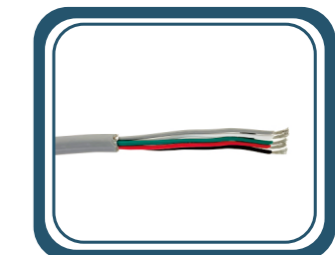
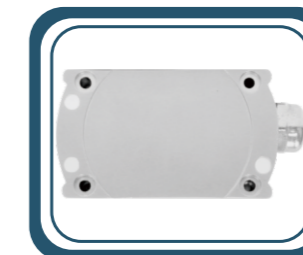

www.such.com

sales@such.com

+86 773 280900

Global Shipping

INCLINOMETER | TILT SWITCH | DIGITAL INCLINOMETER | ELECTRONIC COMPASS ACCELEROMETER | GYROSCOPETHE SYSTEM | INERTIAL MEASUREMENT UNIT ATTITUDE AZIMUTH COMBINATION SYSTEM | GYRO SYSTEM | GPS POSITIONING SYSTEM

DESCRIPTION

MCA416/426T series tilt sensor is a new type of low-cost full-attitude tilt angle measurement product. Adopting the latest anti-interference platform design, integrating new micro-mechanical sensing unit, wide temperature working performance, excellent anti-vibration performance, stable and reliable long-term work, and effective working life of up to 10 years.

This product uses a non-contact principle to measure the tilt angle of an object, and calculates the real-time tilt angle by measuring the component produced by the earth's gravity through an internal capacitive micromechanical unit. The installation is simple and convenient, and it only needs to be fixed on the object to be tested, and does not need to fix the shaft and the rotating shaft. A variety of installation methods to meet customer measurement needs. It is an ideal accessory for engineering machinery, agricultural machinery, and other industrial equipment.

FEATURES

- Resolution:0.1°
- Output: MODBUS
- Six installation methods
- Power supply: 9~36V
- Zero set function
- Work temperature:-40~+85°C
- IP67
- High anti-shock>3500g

SYSTEM DIAGRAM

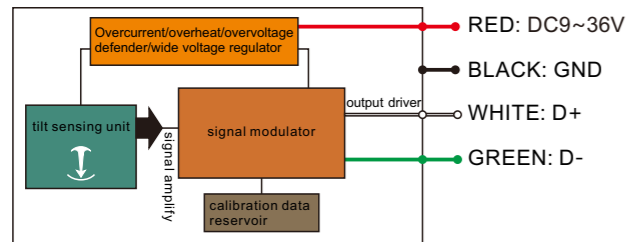

SIZE

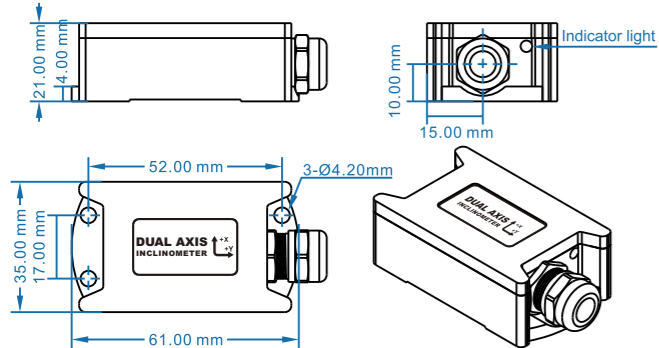

Shell size: L61×W35×H21mm
Installation size: L52×W50×H40mm
outing screws: 3M4 screws

USAGE

1. This product measures the tilt angle of an object by sensing the principle of Earth's gravity. During installation, ensure that the sensor's sensing axis is parallel to the tilt axis of the measured object to achieve optimal measurement accuracy. The sensor must be in close, flat, and stable contact with the measured surface. Uneven installation surfaces may cause measurement angle errors.
2. This tilt sensor can be installed and measured on any of its six faces. After installation, use the "set relative zero point" command to perform zero calibration (this also sets the current installation method, and the setting is saved in the product's internal memory. After zeroing, the product will operate with the current position as the zero-degree reference).
3. The sensor has an IP67 protection rating, meaning it is unaffected by rain or strong water jets. However, please avoid prolonged immersion in water to prevent damage to the internal circuitry. Damage caused by such use will be eligible for paid repair services provided by the manufacturer.
4. After installation, ensure that the signal wire does not short-circuit with the positive power wire during wiring, as this may damage the output circuit. Since the signal ground and power ground of this product are shared, please connect the signal ground of the acquisition end to the power ground of this product.

APPLICATION

- Agricultural machinery
- Lifting machinery
- Crane
- Aerial platform
- Solar tracking system
- Medical equipment
- Electric vehicle control

PARAMETERS

MCA416M/426M	CONDITIONS	PARAMETER	UNIT
Resolution		0.1	°
Accuracy	25°C	±0.2	°
Response Time		0.05	S
Temperature Drift	-40 ~ 85°C	±0.5	°
Output Load		>500 ohm	
Working Time		50000 hours/time(no fault)	
Insulation Resistance		>100 ohm	
Anti-shock		10grms、10~1000Hz	
Impact Resistance		100g@11ms,3 Axial Direction (Half Sinusoid)	
Weight		≤200g(Including 1m line)	
Certificate		CE ; APPEARANCE PATENT	
Quality System		IATF16949: 2016 (Certificate No.: T178487) GJB9001C-2017 (Registration No.: 02622J3179R0M)	

ORDER GUIDE

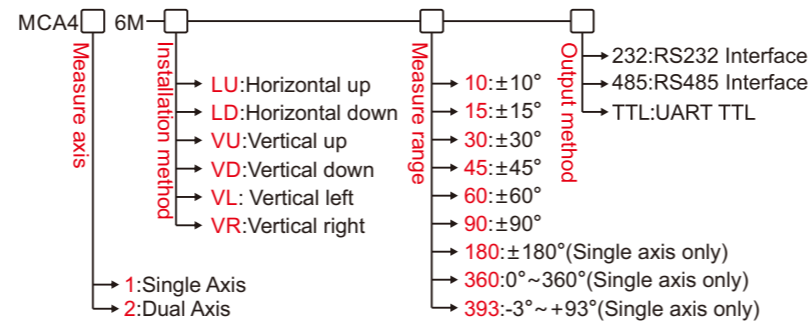

E.g: MCA416M-LU-10: Single axis, Horizontal Up, ±10° Measure range.
Note: The measuring range 0°~360° is limited to X-axis (clockwise rotation), and the installation method only support "VU" optional.

CONNECTION

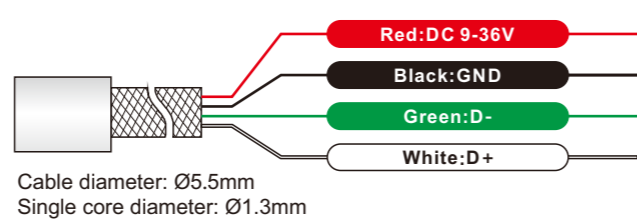

INSTALLATION DIRECTION

▶ HORIZONTAL MEASUREMENT INSTALLATION DIRECTION

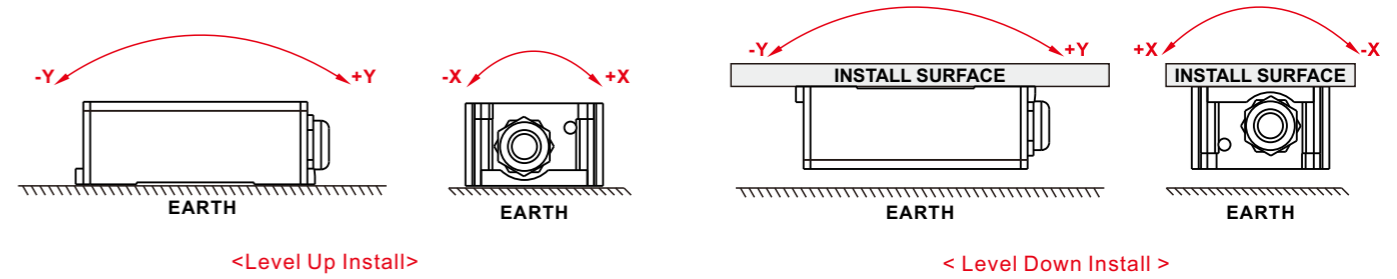

▶ VERTICAL MEASUREMENT INSTALLATION DIRECTION

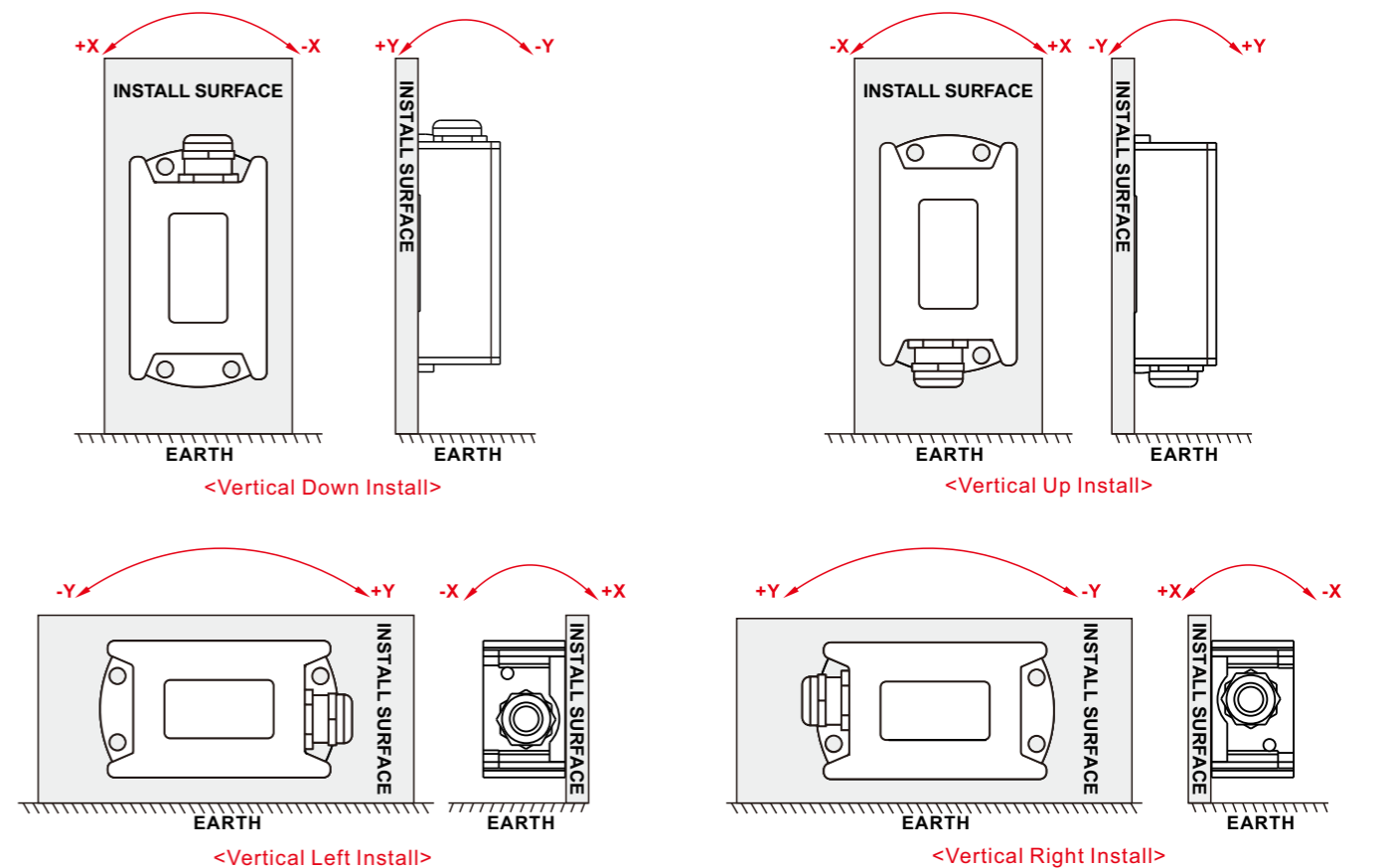

Remarks: The factory default installation is horizontal upward, the user can sets the corresponding installation method according to needs, please refer to Article 2 of the operating instructions, and make the corresponding settings.

PRODUCT MODBUS PROTOCOL

Note: Please read the following items carefully before use:

- 1) MODBUS protocol stipulates that it should be over 3.5 byte time between two data frame (Eg. Under 9600 baud rate, the time is $3.5 \times (1/9600) \times 11 = 0.004s$). This sensor increase the time to 10ms for a enough margin, so please set 10ms time interval at least between each data frame.
Host send command--10ms interval--slave response command--10ms time interval--host send command...
- 2) MODBUS protocol stipulates broadcast address--content relate to 0. This sensor also capable of receiving broadcast address content but without response. So broadcast address 0 could be used as (below is reference only):
1. Set all the addresses of inclinometers mounted on BUS with this Model NO as one address.
2. Set all the inclinometers mounted on BUS with this Model NO to be relative/absolute zero.
3. Test all inclinometers mounted on BUS. Host inquires angle command by sending 0 address to BUS, if the communication light flashes, then communication is in proper function.
4) for sake of system reliability, when set address and relative/absolute command, it should be send two times continuously, which means two successful sending with continuous responses by slave, that is no data frame between the two inquiries, or the command will be locked till power off. Set as below:
Send set address command--stand by for slave response set success command--send again set address command(no other command between)--stand by for slave response set success command--successful revision
After power-up, two set commands mentioned above could be only set once, if need reset, please set after power on again.
- 5) the communication light will flash once when proper communications accumulate to a ceratin times.